



| PHENOLIC MOTOR PROTECTORS

Non-Hermetic Motor Protector for Single-Phase On-Winding Protection

Introduction

Klixon Phenolic Motor Protectors are equipped with a bimetallic snap acting disc, on which the contacts are mounted, and through which the current flows. If overheating conditions occur, the heating effect of the current flow through the Klixon disc and the influence of motor heat will cause the disc temperature to rise.

When the disc reaches the calibrated setpoint, the Klixon protector automatically opens and shuts down the motor, limiting the winding and shell temperature.

When the motor has cooled to an acceptable operating level, allowing the protector to cool to its reset temperature, the Klixon protector resets automatically to a closed contact position allowing the motor to restart.

Manual reset versions are also available for applications where automatic restarting may be hazardous to equipment or operations.



Features

- Normally closed “make or break” Klixon® contact system, which is operated by a snap action disc, is sensitive to both temperature and current.
- Precision calibration – temperature calibrated and inspected under controlled conditions for dependable performance.
- Automatic or manual reset series available
- Easy to install
- VDE certificate with production surveillance, overheating protector. 37 amperes maximum locked rotor 230 VAC, File 4464.4-4510-1013, License No. 3938 UG for 3/4” M.P. only.
- Inherent protection devices for approximately 1/2 to 5 h.p. motors used in applications such as industrial motors, agricultural equipment, well and sump pumps, fans, air conditioners, refrigerators, home appliances, etc.
- When properly applied, protector shuts off motor when temperature exceeds maximum safe level due to an overload or stalled (locked rotor) condition.



SPECIFICATIONS

Diagrams

Automatic Reset Exploded View

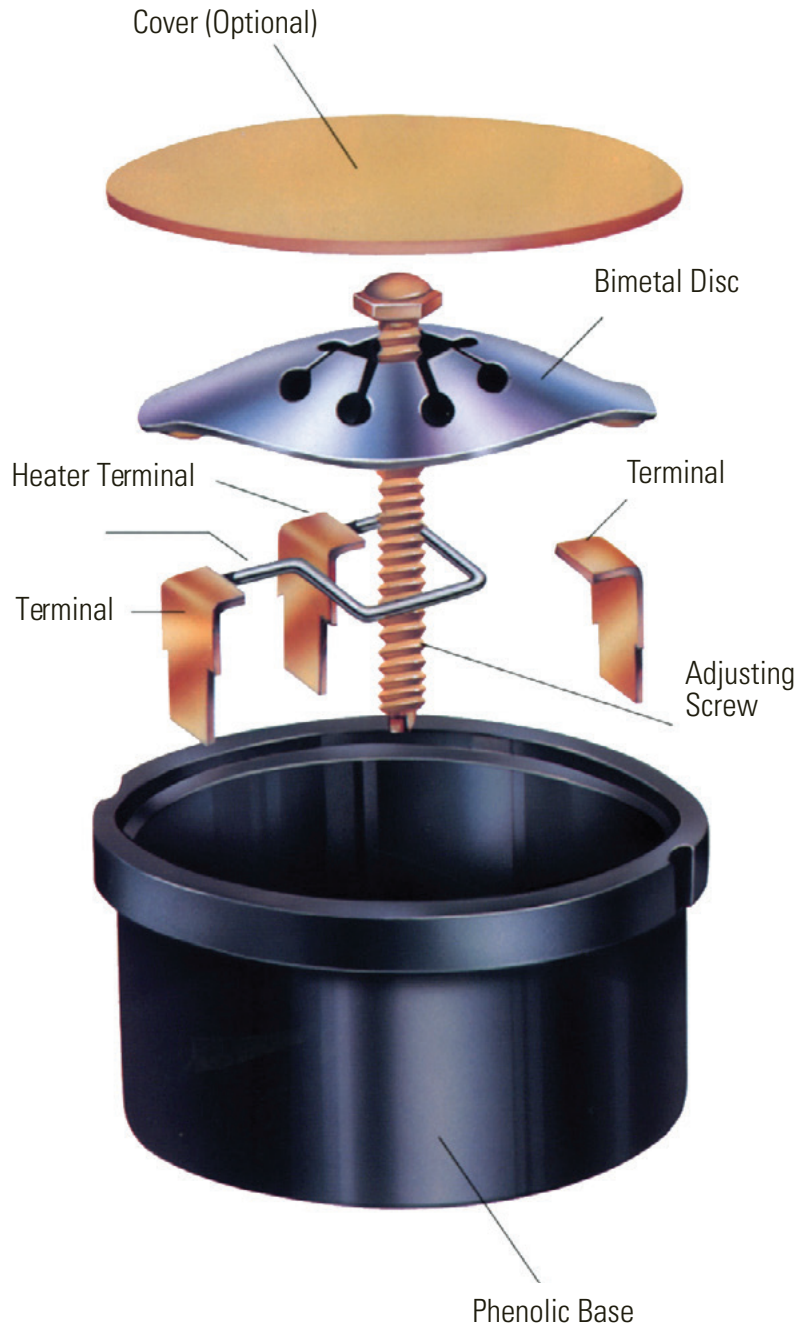

Contacts Open

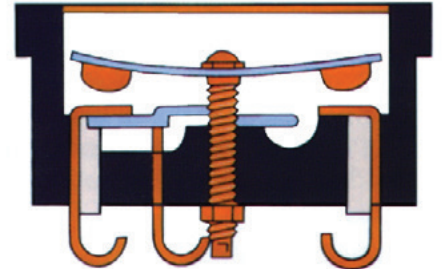

Contacts Closed

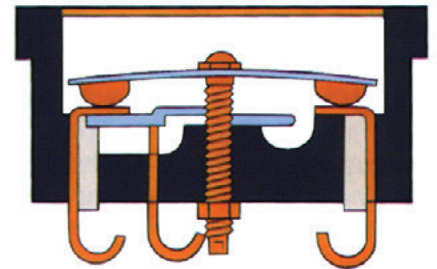

Manual Reset

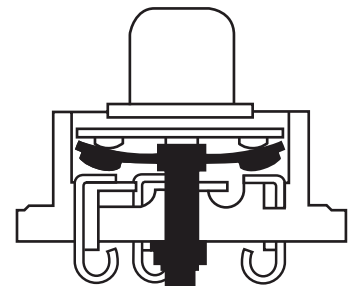

Curves

**Ultimate Trip Current
vs
Protector Ambient Temperature**
(Approximate, to be used only for selecting samples for motor verification test)

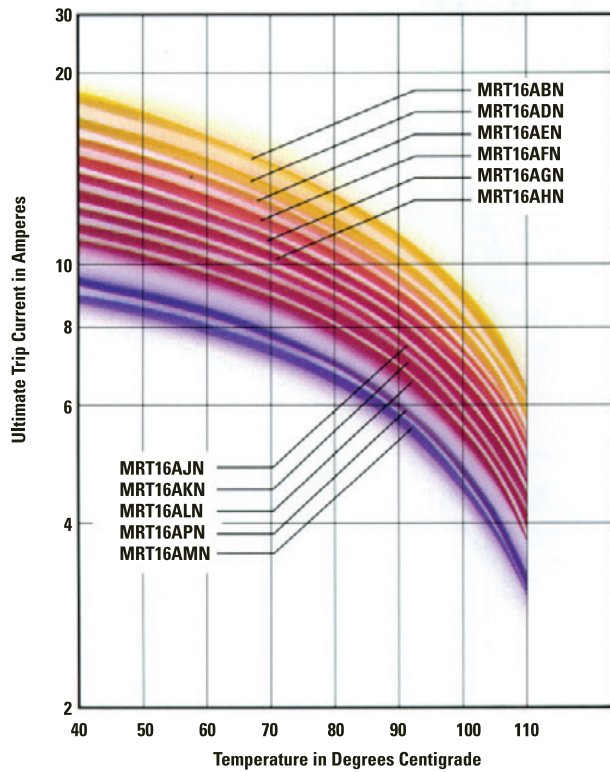

**Average first Cycle Tripping Time
vs
Current in 25°C Ambient**
(Approximate, to be used only for selecting samples for motor verification test)

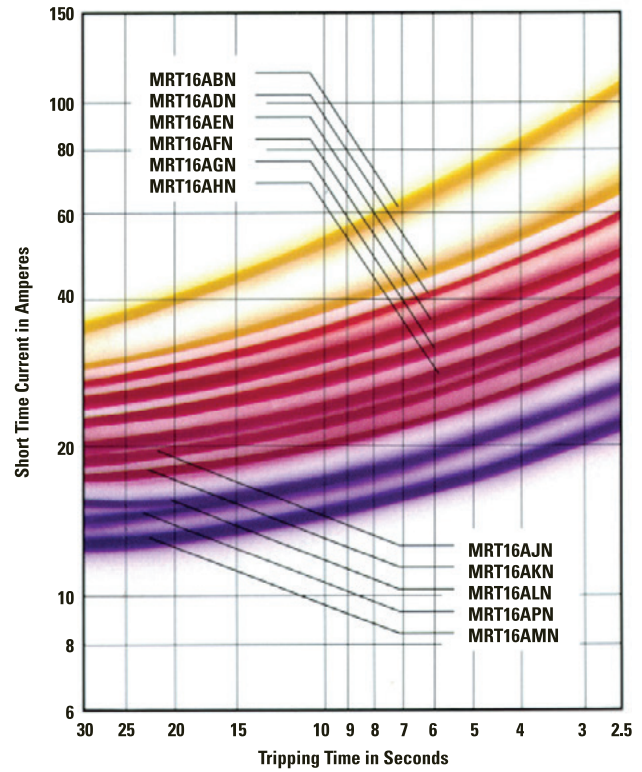

Note: Other ratings available for single and three phase applications.
Computer software is available to assist in application.



DIMENSIONS

Metric Dimensions in Parentheses

Round Base

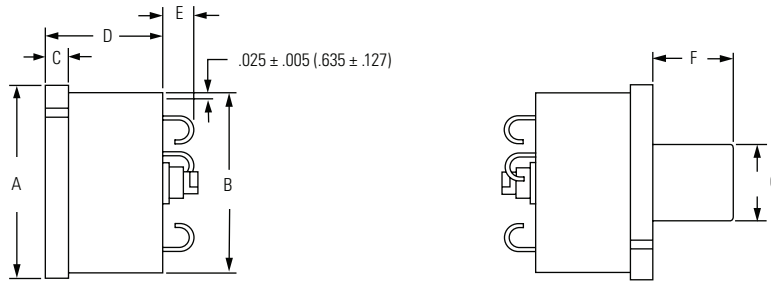

Type	Size	A	B	C	D	E Max.	F	G
MR	3/4"	1.031 ±.010	.970 ±.006	.125 ±.005	.625 ±.010	.171	23/64 ±1/32	.375 ±.006
CR	1"	1.312 ±.010	1.218 ±.010	.125 ±.005	.640 ±.010	.218	31/64 ±1/32	.442 ±.006
BR	1-1/4"	1.640 ±.010	1.555 ±.010	.156 ±.010	.930 ±.015	.313	27/64 ±1/32	.442 ±.006
LR	1-1/2"	1.983 ±.010	1.881 ±.010	.154 ±.010	.830 ±.015	.375	15/32 ±3/64	.781 ±.006

Eared Base

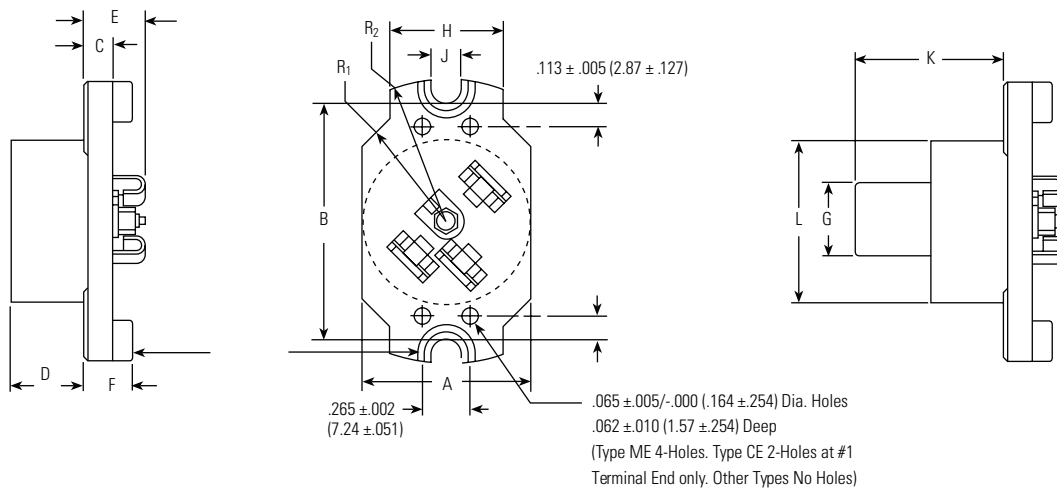

Type	Size	A	B	C	D	E	F	G	H	J	K	L	R ₁	R ₂
ME	3/4"	.970 ±.010	1.390 ±.015	.175 ±.010	.450 ±.015	.354	—	.436 ±.007	.625 ±.010	.176 ±.010	.953	.970 ±.006	.656 ±.010	.845 ±.010
CE	1"	1.187 ±.010	1.390 ±.015	.175 ±.010	.464 ±.015	.406	—	.440 ±.008	.625 ±.010	.176 ±.010	1.000	1.187 ±.010	.656 ±.010	.845 ±.010
BE	1-1/4"	1.594 ±.010	2.125 ±.010	.223 ±.010	.715 ±.010	.552	.332 ±.010	.440 ±.008	1.000 ±.010	.218 ±.010	1.180	1.552 ±.010	.844 ±.010	1.344 ±.010
LE	1-1/2"	1.875 ±.010	2.125 ±.020	.267 ±.010	.890 ±.010	.683	.517 ±.010	.781 ±.006	1.250 ±.010	.218 ±.010	1.370	1.875 ±.010	1.000 ±.010	1.344 ±.010



ORDERING OPTIONS

Example : M R P 36 A X - 63

Size	X	X	X	#	Y	Z	-	##
M = 3/4" C = 1" B = 1-1/4" L = 1-1/2"								
Base								
E = Eared commercial R = Round commercial Ct = Round commercial, cut down and cover G* = Eared commercial and cover S* = Round commercial and cover * Except 1-1/4" size which always has cover. E&R designate this. * Only 1-1/2" applications.								
Terminals								
F = 2 solder low cap H = 2 solder high cap K = 2 std screw low cap M = 2 std screw high cap P = 2 stub low cap T = 2 stub high cap G = 3 solder low cap J = 3 solder high cap L = 3 std screw low cap O = 3 std screw high cap P = 3 stub low cap T = 3 stub high cap								
Heater								
Selected to satisfy application requirements								
Disc and Contact								
See Table on Page 6								
Operating Temperature								
See Table on Page 6								
Terminations								

Maximum Recommended Protector Contact Ratings

This chart is used to determine protector size needed when making an application.

Size	Disc Contacts	Terminals	Max. Current V = 120	Max. Current V = 240
3/4"	HC	LC	32	25
3/4"	HC	HC	50	37
1"	LC	LC	40	30
1"	HC	LC	40	30
1"	LC	HC	40	30
1"	HC	HC	80	60
1 1/4"	STD	STD	135	100
1 1/2"	STD	STD	175	130

HC = High Capacity **LC** = Low Capacity **STD** = Standard Capacity
For reference only. Please contact Sensata for application assistance.

Disc and Contact

3/4"		1"	
High Cap		Low Cap	High Cap
A	AB	F	C
B	AD	G	D
C	AE	J	E
D	AF	P	H
E	AG	L	I
	AH	S	K
	AI	O	
	AJ	T	
	AK	AB	
J	AL	AE	X
	AM	AF	
L	AP	AG	
		AH	
R		AI	
		AJ	
		AK	
		AL	
		AM	
		AN	

Operating Temperature

Automatic Reset		
Open $\pm 5^{\circ}\text{C}$		Close $\pm 9^{\circ}\text{C}$
J	= 90	57**
K	= 105	61
L	= 105	69
V	= 105	78
Z	= 120	61
N	= 120	69
X	= 120	78
Y	= 120	92
W	= 135	61
U	= 135	69
M	= 135	78
R	= 135	92
S	= 135	102
H**	= 150**	78**
P**	= 150**	115**
O**	= 150**	102**
Manual Reset		
Open $\pm 5^{\circ}\text{C}$		Close $\pm 12^{\circ}\text{C}$
G	= 90	54**
F	= 105	63***
A	= 105	74*
B	= 120	74
D	= 135	96
E**	= 150**	96**
* 1-Phase Protectors only. ** Special temperatures. Consult net additions. *** 3-Phase Protectors only.		



APPLICATION WORKSHEET

A sample worksheet provides the information needed for a proper application. It is not possible to apply a Klixon protector based on horsepower, amperage, or name plate data only.

Motor Data

A. Locked Rotor Requirements

1. Locked Rotor Current Cold: the current which exists the instant the motor is turned on.
2. Locked Rotor Current Hot: The current level that exists at end of 1st cycle test. Typically 10 to 30 seconds after motor is first turned on.
3. Time elapsed during above test to raise motor winding temperature from room temperature to around maximum allowed temperature for the UL class of motor insulation. An example would be, for a class A motor, 25°C to 175°C in 12.5 seconds.
4. Ambient Temperature During test: Room temperature (usually 25°C).

B. Running Overload Requirements

1. Load Current: With the motor running, the load on the motor is to be increased in small increments until the motor winding has completely stabilized at approximately 10°C below the maximum allowed by the UL class of the motor. An example would be, for a class A motor, the maximum allowed is 140°C. The motor winding temperature was completely stabilized at 130°C and the current draw at that time would be recorded.
- 2&3. Protector Location Temperatures: These temperatures are taken at the conclusion of the above load current test while the motor is running under the above load.
4. Ambient Temperature: Room temperature (usually 25°C).

C. Abnormal Conditions for Protection.

1. Max/min Ambient Temperatures: temperature in the surroundings of protector.
2. Max/min Line Volts: The highest and lowest voltages for which protection should be effective.
3. Other environmental considerations: i.e., exposed to agricultural weather conditions.

Name Plate Data

- A. Horsepower
- B. Voltage
- C. Single or three phase
- D. FLA (full load amps)
- E. LRA (locked rotor amps)
- F. Insulation class (UL/CSA) (indicate one)

	H.P
	Volts
	Phase
	Amps
	Amps
	ABFH

Protector Requirements

- A. Automatic or manual reset
- B. Round or eared base
- C. Termination type

Motor Data Required

- A. Locked rotor requirements
 1. Locked rotor current cold
 2. Locked rotor current hot
 3. Time required to raise motor winding to max. temperature
 4. Ambient temperature during test
- B. Running overload requirements
 1. Load current required to stabilize main winding temp. at 10°C below maximum allowed
 2. Protector location temperature below protector surface
 3. Protector location temperature above protector (air temp)
 4. Ambient temp during test
- C. Abnormal conditions for protection
 1. Max/min ambient temperatures
 2. Max/min line volts
 3. Other environmental considerations

	Amps
	Amps
	Sec
	Deg
	Amps
	Deg
	Deg
	Deg
	Deg
	Volts
	Volts

Note: Application assistance available from Sensata.

Sensata Technologies, Inc. ("Sensata") data sheets are solely intended to assist designers ("Buyers") who are developing systems that incorporate Sensata products (also referred to herein as "components"). Buyer understands and agrees that Buyer remains responsible for using its independent analysis, evaluation and judgment in designing Buyer's systems and products. Sensata data sheets have been created using standard laboratory conditions and engineering practices. Sensata has not conducted any testing other than that specifically described in the published documentation for a particular data sheet. Sensata may make corrections, enhancements, improvements and other changes to its data sheets or components without notice.

Buyers are authorized to use Sensata data sheets with the Sensata component(s) identified in each particular data sheet. HOWEVER, NO OTHER LICENSE, EXPRESS OR IMPLIED, BY ESTOPPEL OR OTHERWISE TO ANY OTHER SENSATA INTELLECTUAL PROPERTY RIGHT, AND NO LICENSE TO ANY THIRD PARTY TECHNOLOGY OR INTELLECTUAL PROPERTY RIGHT, IS GRANTED HEREIN. SENSATA DATA SHEETS ARE PROVIDED "AS IS". SENSATA MAKES NO WARRANTIES OR REPRESENTATIONS WITH REGARD TO THE DATA SHEETS OR USE OF THE DATA SHEETS, EXPRESS, IMPLIED OR STATUTORY, INCLUDING ACCURACY OR COMPLETENESS. SENSATA DISCLAIMS ANY WARRANTY OF TITLE AND ANY IMPLIED WARRANTIES OF MERCHANTABILITY, FITNESS FOR A PARTICULAR PURPOSE, QUIET ENJOYMENT, QUIET POSSESSION, AND NON-INFRINGEMENT OF ANY THIRD PARTY INTELLECTUAL PROPERTY RIGHTS WITH REGARD TO SENSATA DATA SHEETS OR USE THEREOF.

All products are sold subject to Sensata's terms and conditions of sale supplied at www.sensata.com. SENSATA ASSUMES NO LIABILITY FOR APPLICATIONS ASSISTANCE OR THE DESIGN OF BUYERS' PRODUCTS. BUYER ACKNOWLEDGES AND AGREES THAT IT IS SOLELY RESPONSIBLE FOR COMPLIANCE WITH ALL LEGAL, REGULATORY AND SAFETY-RELATED REQUIREMENTS CONCERNING ITS PRODUCTS, AND ANY USE OF SENSATA COMPONENTS IN ITS APPLICATIONS, NOTWITHSTANDING ANY APPLICATIONS-RELATED INFORMATION OR SUPPORT THAT MAY BE PROVIDED BY SENSATA.

Mailing Address: Sensata Technologies, Inc., 529 Pleasant Street, Attleboro, MA 02703, USA.

CONTACT US

Americas

+1 508 236 2551
electrical-protection-sales@
sensata.com

Europe, Middle East & Africa

+3 174 357 8156
info-sse@list.sensata.com

Asia Pacific

EP_Asia_Public@list.sensata.com
China +86 (21)2306 1651
India +91 (40)4033 9611
Japan +81 (45)277 7104
Korea +82 (53) 644 9685
Rest of Asia +65(6478)6860